

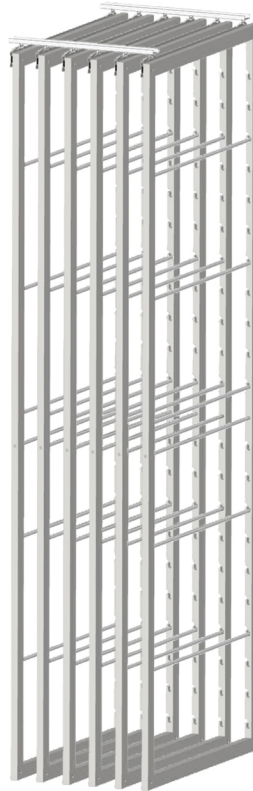

OUT OF SIGHT AND OUT OF THE WAY!®



Original
30"
Version

Cabinet Design and Installation Instructions

2,4,6, and 8 frames

SCAN CODE WITH PHONE CAMERA BELOW FOR ADDITIONAL HELP

Watch an instructional video on DryAway.net



Tap. Zoom. Rotate with the interactive instructions on the BILT app



Cabinet Design

(Cabinet Not Included)



IMPORTANT! 2 frame ceiling hardware must be installed while building the cabinet or closing off the space

The following cabinet design is the most functional, efficient, and easy way to build a cabinet to house DryAway (not the only way). The cabinet that houses DryAway is best constructed with parts instead of building out a typical cabinet box. Think “30-inch-deep end panels” with a solid top to mount the DryAway from. If the cabinet is delivered preassembled it will be difficult to get it into the house. Assembling the cabinet onsite is recommended.

PARTS LIST

- End Panels (30” x 96” x ¾”) one or both sides – “Traditional” with the stile or “Frameless” without the stile
- Filler Board (3” x 6’ x ¾”) – used to make cleats and front rail
- Crown Molding as desired
- Ceiling Panel (Width (see below) x 30” x ¾”)

Finished Cabinet (Cabinet Not Included) - Ideal Inside Dimensions to House Finished Product

- 2 frame – 9”W (8”W-Minimum) x 30”D x 90”-96”H (229mm x 762mm x 2286mm - 2438mm)
 - 4 frame – 15”W (14”W-Minimum) x 30”D x 90”-96”H (381mm x 762mm x 2286mm - 2438mm)
 - 6 frame – 24”W (21”W-Minimum) x 30”D x 90”-96”H (610mm x 762mm x 2286mm - 2438mm)
 - 8 frame – 30”W (28”W-Minimum) x 30”D x 90”-96”H (762mm x 762mm x 2286mm - 2438mm)
- (Floor to ceiling height is best between 90” and 96”)

No Cabinet Base. A typical cabinet base will push the clothes drying up 3-4 inches which is small but critical vertical height lost. A design without the cabinet base (toe kick) still provides a high end finished look with the flooring continuing under the cabinet.

No Doors. To guarantee proper drying no doors should be used. Closing off the space will not let the evaporation/moisture out of the space. DryAway with all the frames filled and pushed in, out of sight and out of the way will dry at the same speed as clothes on a typical accordion rack in the middle of the same room. Just evaporation. No fans needed.

ACTUAL PRODUCT DIMENSIONS (without the required clear space to dry)

All frames are 29-1/4” deep and 85” tall from the bottom of the frame to the ceiling mounting surface. Frames are spaced 3-1/4” on center line of each frame (or from mounting bracket tab to tab). See above for interior cabinet clear space needed.

- 2 frame – 4” total width
- 4 frame – 10-1/2” total width
- 6 frame – 17” total width
- 8 frame – 23-1/2” total width

Cabinet Design

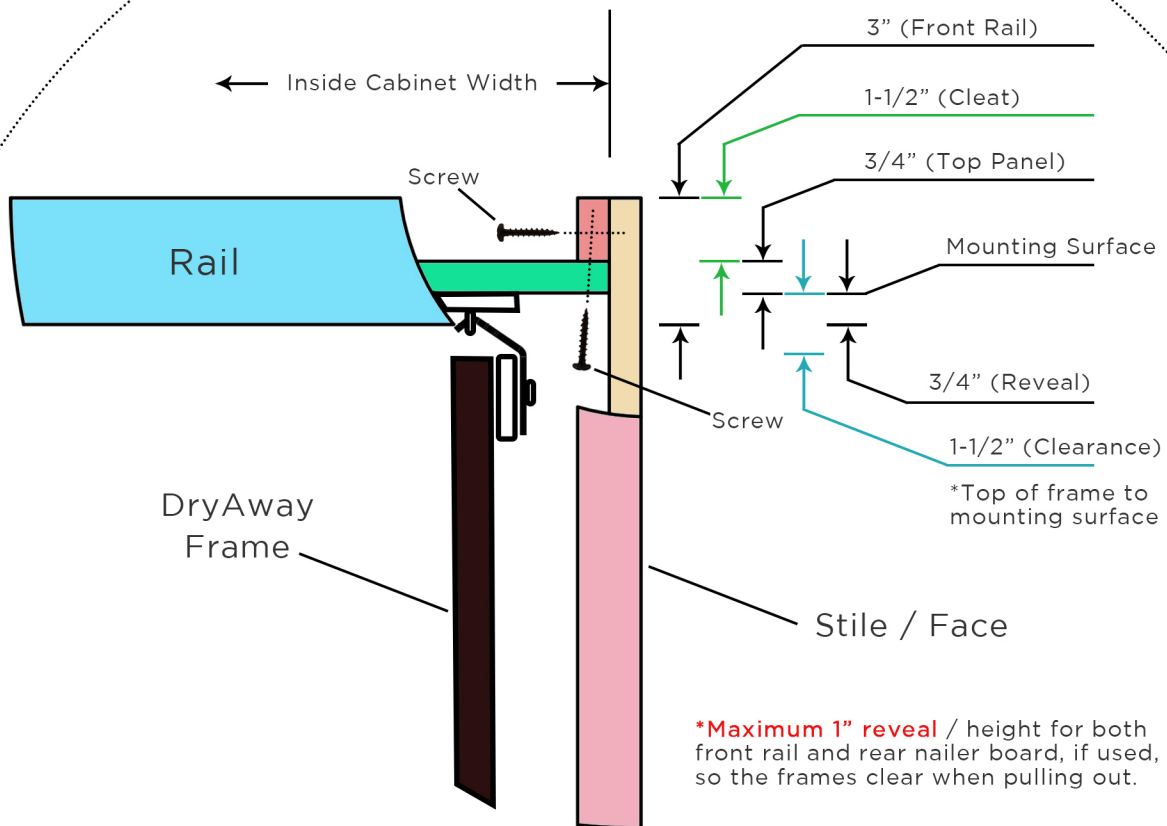
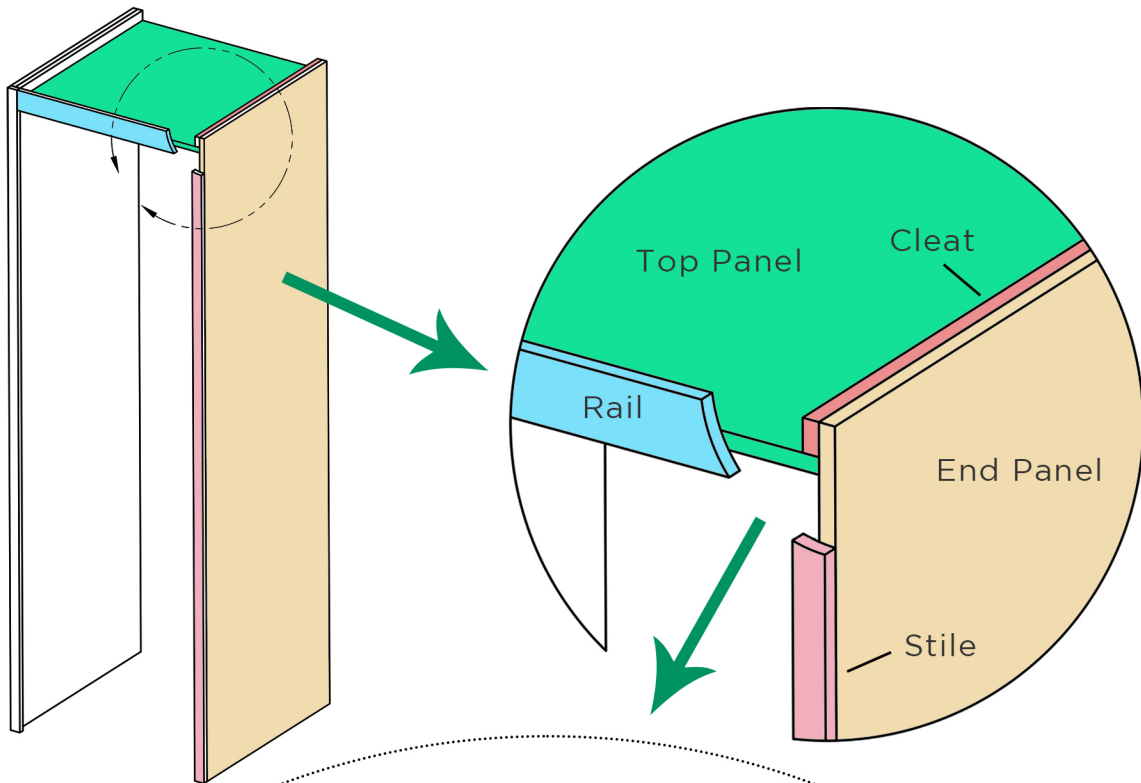

Cabinet Design (Cabinet Not Included)

Step 1

Cut End Panels to size planning for a mounting height (floor to underside of ceiling) between 90" and 96" (2286mm -2438mm)

Step 2

Cut a 29-1/4" section off the 3" filler piece and rip it in half to make two cleats. The rest of the filler will be used for the top front rail in step 5.

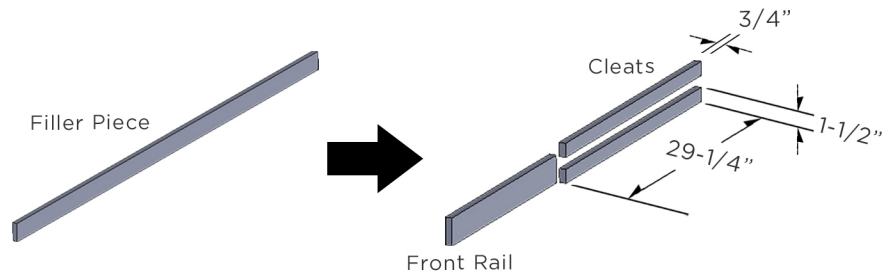

Step 3

Attach cleats to the end panels with 1-1/4" wood screws

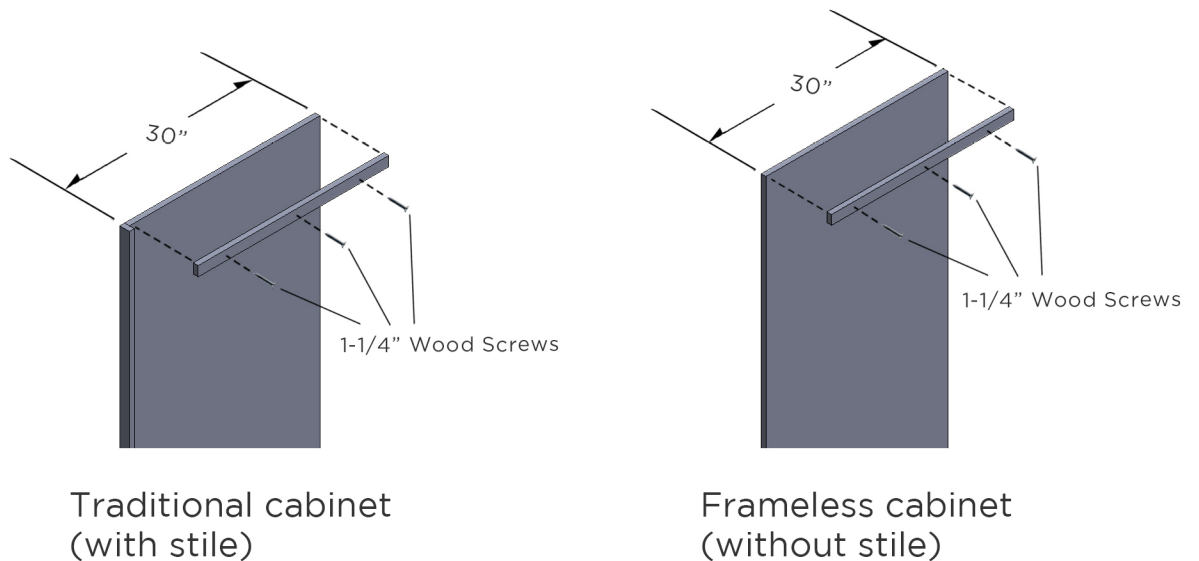

Step 4

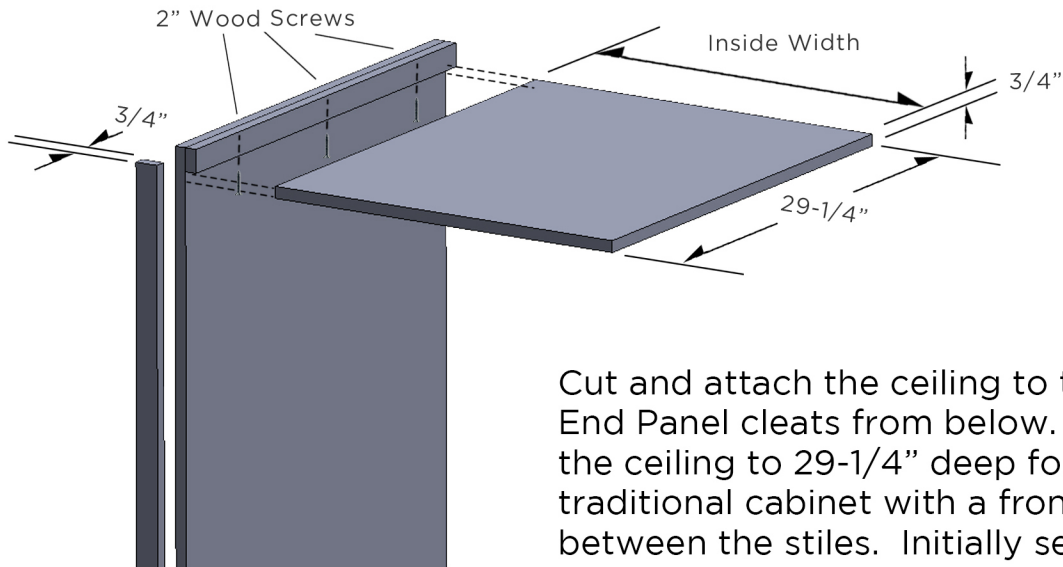

Inside Width

- 2 frame - 9"W
- 4 frame - 15"W
- 6 frame - 24"W
- 8 frame - 30"W

Cut and attach the ceiling to the End Panel cleats from below. Cut the ceiling to 29-1/4" deep for a traditional cabinet with a front rail between the stiles. Initially secure with a nail gun but be sure to use 2" wood screws to provide vertical strength to support the load of DryAway hanging from the ceiling. Again, the ceiling must be made from a solid 3/4" thick material.



IMPORTANT! 2 frame ceiling hardware must be installed while building the cabinet or closing off the space

Step 5

Cut and attach the top front rail to fit between the stiles. Add crown molding as desired.

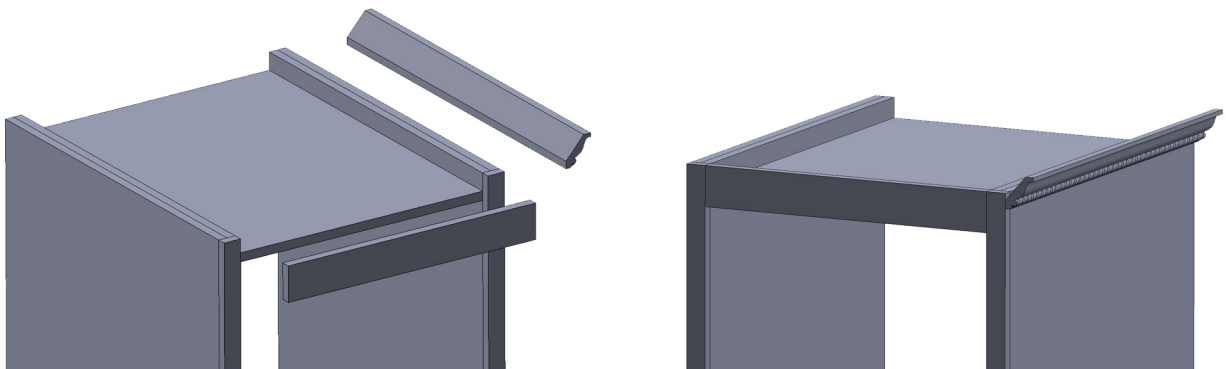



IMPORTANT! The ceiling will carry all the load. A solid 3/4” surface is required to support the DryAway mounting hardware. Screw (not nail) the ceiling panel up into side support cleats. See cabinet design drawing to confirm your cabinet dimensions. **DryAway is not responsible for improper installation, modifications or unintended use of this product.**

INSTALLATION: Tools needed:

- **2 - Folding Tables** (not required but makes assembly much easier)
- **2 - Moving blankets**
- **Ladder** (small two step)
- **Tape measure**
- **3/8” wrench**
- **Pencil or marker**
- **Masking tape**
- **Scissors and box knife**
- **Drill with 3/32” drill bit and #2 Philips bit**
- **#2 Philips screw driver**

Watch Installation Video



Scan with Phone Camera



Setup:

1 - Setup Assembly Space with two folding tables covered with moving blankets. Make sure the tables are spread wide enough to assemble each end of the frames. Gather tools, as needed, from the list.

2 - Open each box and gather the mounting brackets and hardware before building out frames.



Brackets



**Hooks, Hook Supports
& Connector Plugs**



Hardware

PARTS LIST: Each box contains parts for 2 frames:

- (A) **Template** for drilling the center pilot holes for the mounting brackets
- (B) **4 hook supports**
- (C) **2 mounting brackets**
- (D) **2 connector plugs**
- (E) **4 slider hooks**
- (F) **2 frames (8 parts - 2 tops w/ logos, 2 bottoms, 2 sides w/ holes and 2 sides w/ slots) *Not Shown**
- (G) **10 cross rods** all wrapped in one bag
- (H) **2 spacer rods** in a second bag
- (I) **2 Sliders**

Hardware Bag with:

- (J) **4 (+1 extra) - 1-1/4" #8 flat head wood screws**
- (K) **8 (+1 extra) - M6 x 20mm flat head machine screws**
(nut already inserted in frame)
- (L) **4 (+1 extra) - M5 x 50mm flat head machine screws** (for spacer rods)
- (M) **6 (+1 extra) - 5/8" #6 flat head wood screws**
(for attaching slider to frame)
- (N) **10 (+1 extra) - #10 rubber O-rings** (one per cross rod)
- (O) **4 Nuts (+1 extra)**
- (P) **4 Screws (+1 extra)**

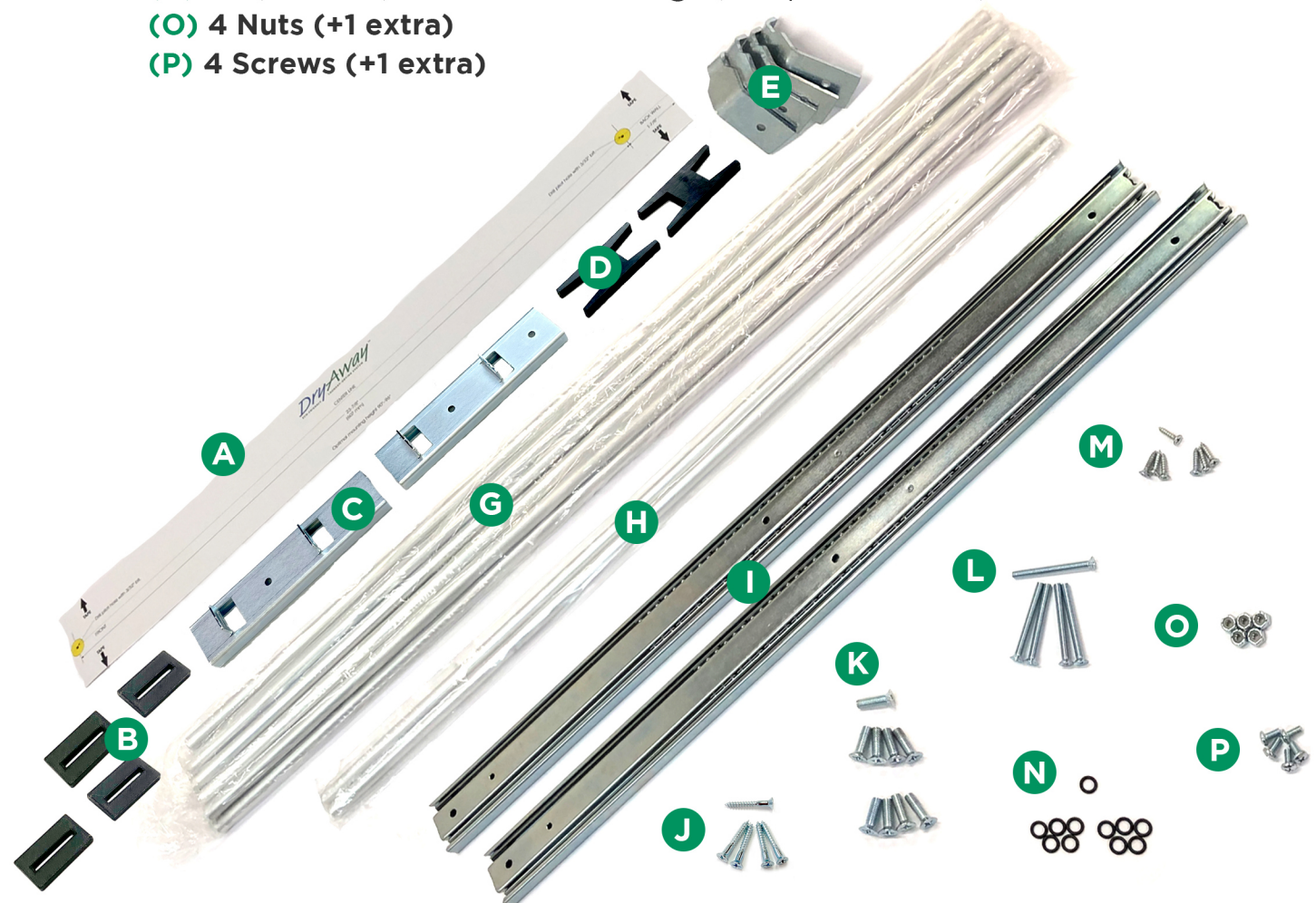



IMPORTANT! Only attach the mounting hardware to a solid 3/4" surface that can support DryAway

Installation:



1 - Installing mounting brackets. Measure the width of the back wall at the ceiling to find the center line for DryAway. Mark the center line on the back wall just below the ceiling in line. Measure 26" from the back wall on the ceiling and mark the center line for the front mounting bracket.



2 - Attach the template to the ceiling mounting surface. Put two pieces of tape on both ends of the mounting templet where it says “tape =>”. Starting with the back, line up the center line on the template with the mark you created and tape the template tight to the back wall. Slide your hand on the template forward to remove slack and attach the front of the template matching the other center line mark you created.



3 - Drill pilot holes with a 3/32” drill bit. Drill the pilot hole 1/4” deep where indicated at the back and front of the template on the mounting surface. Remove the template. These are the middle holes for each of the mounting hook brackets.



4 - Determine loading side. Both sides of the DryAway frame can be used to load/unload clothes from, but one side looks nicer with the logo facing you and the slider hidden on the other side. Normally if you have a washer and dryer located on the left side of DryAway you would want a left side load. The left side load photo above has the slider on the right side for example. In this case there is a wall on the right side.

Left Side Load

Right Side Load

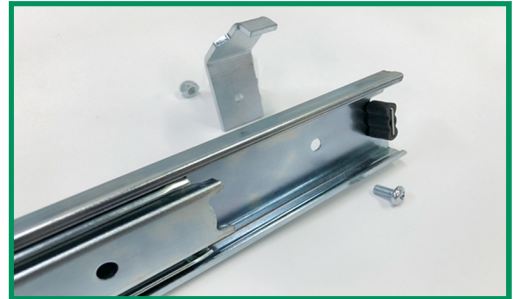
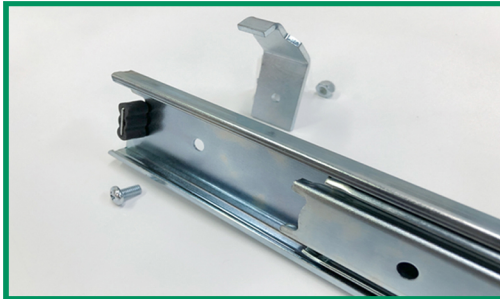

(Rear hook assembly)

(Rear hook assembly)



(Front hook assembly)

(Front hook assembly)

(For a right side load, rotate the hooks 180°)

5 - Assemble hooks to sliders. Lay your slider out and orientate the hooks and assemble as shown. Fully extend the slider to expose the mounting holes. The screws should be inserted on the inside of the slider. Add the hook to the outside of the slider with the lock nut outside of that. Make sure that the hooks are squared up and all positioned the same. The hooks should be tightened so that the hooks don't move but don't over tighten.

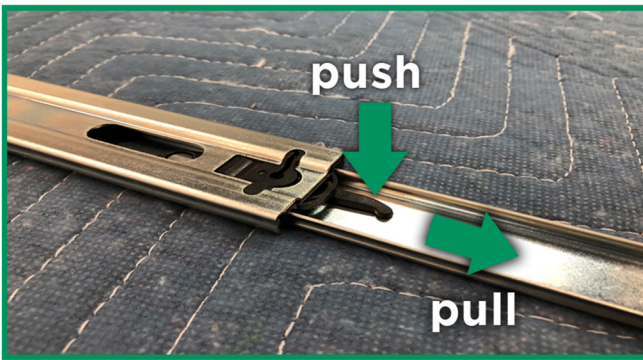
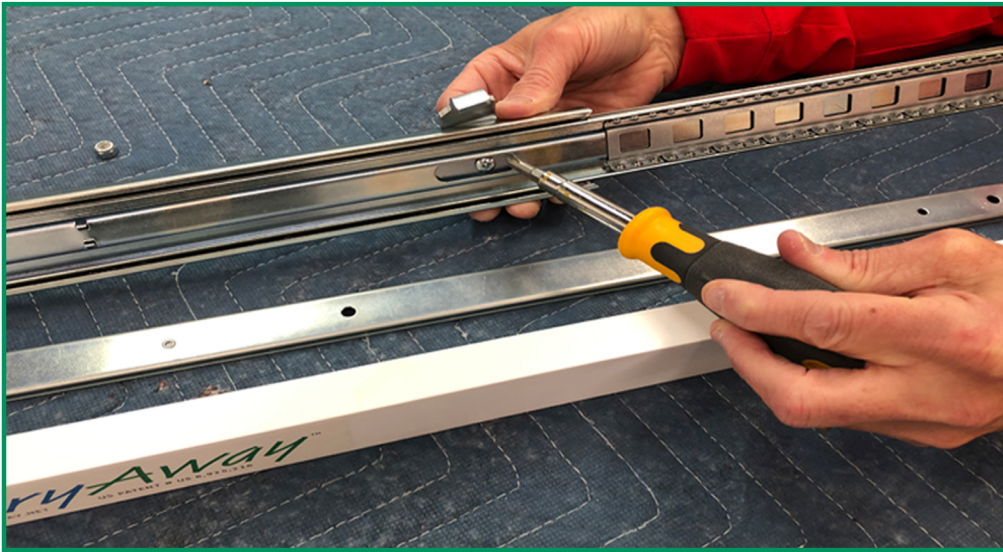

(O) 4 Nuts (+1 extra)
#10-32 lock nut - for hook assembly



(P) 4 Screws (+1 extra)
#10-32 x 3/8" #2 Phillips pan head



(E) 4 Slider hooks



6 - Remove the Inner member of sliders. Pull the slider out all the way and pinch the black plastic release and continue pulling the inner member of the slider out. Lay them next to your frame parts to match the proper assembly direction.

7 - Mounting Bracket Assembly (redesigned) Each box contains 2 mounting brackets for each 2-frame unit. For additional frames, the brackets connect in series using the provided Connector Plugs as shown.

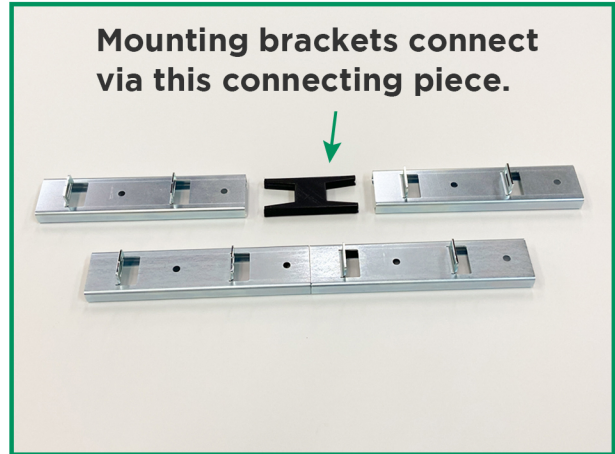
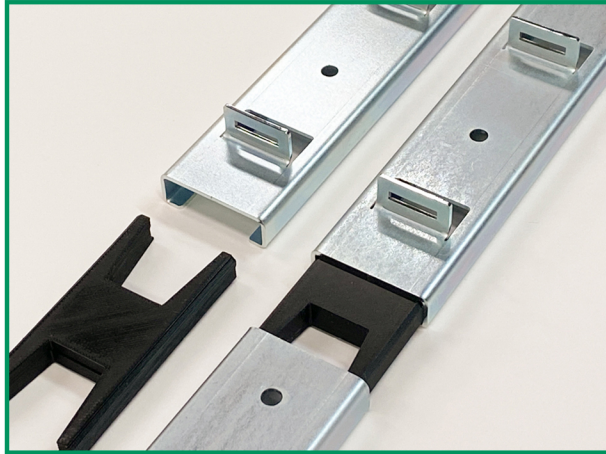

8 - Slide the Plastic Hook Support over the Tabs. The hook supports should have the chamfered side opening as the leading side so that they slide on easy and lay flat.

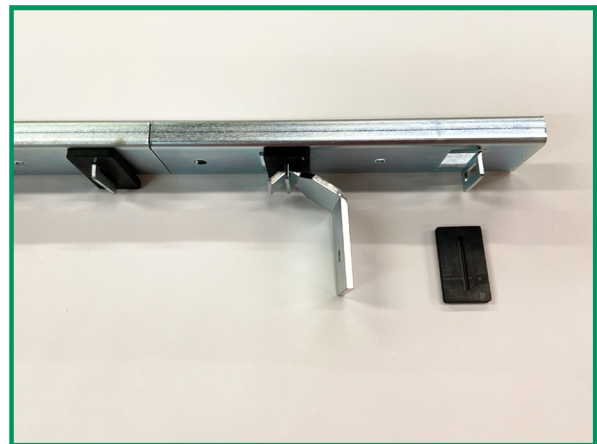
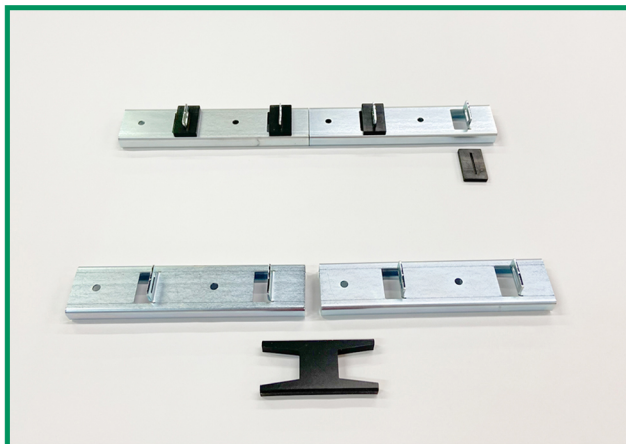

9 - Attach the back-mounting hook bracket with the provided 1-1/4" #8 flat head wood screw in the center hole. (If there is a layer of drywall between the brackets and the solid 3/4" panel then use a 2" #8 flat head wood screws to make up the difference). Position the mounting hook brackets so that the large openings in the brackets are on the same side that the sliders will be on for the best visual look. With your drill and #2 bit, screw the center screw in semi-tight.

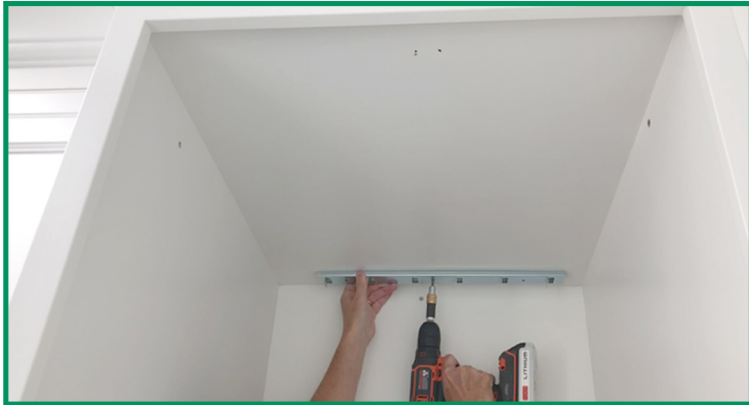

10 - Position the bracket so that it is parallel to the back wall and tighten the center screw to hold the bracket in place. Drill pilot holes with the 3/32" bit in the other holes of the back-mounting hook bracket and screw the mounting screws in tight.



11 - Attach front-mounting hook bracket. Repeat the above process only after attaching with the middle screw, take two of the sliders (with the hooks squared up and the inner members removed) and insert them into the outside hooks (one left and one right). Wiggle them front to back and find the even position for the bracket and tighten the middle screw of the front-mounting hook bracket. Finish off the other screws with the same predrilling process.



IMPORTANT! Remove one of the sliders from the hooks to minimize the chance of it falling and injuring you or damaging the floor. Without the frame attached, the slider doesn't hang vertically and can easily fall out.

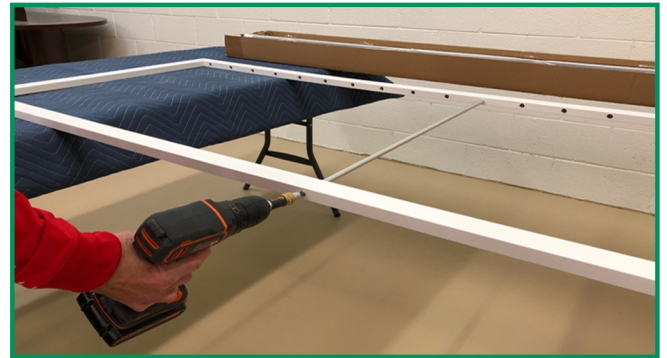
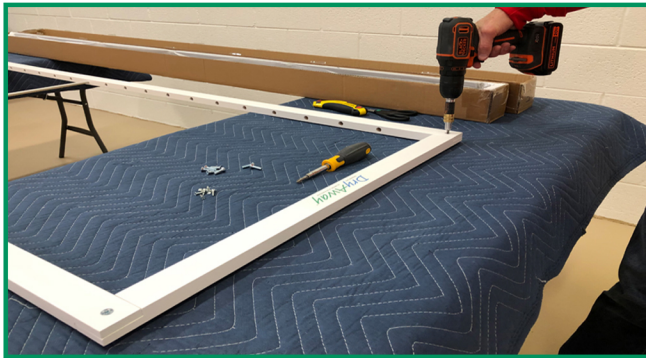

12 - Build out a frame by laying out the 4 pieces on a moving blanket or carpet. The side members have a longer space at one end which is the top. Screw M6 x 20mm flat head screws into the 4 corners of the frame with a cordless drill or screw driver. Add the spacer rod with the 2 M5 x 50mm long flat head screws. Don't over tighten with the drill. Finish all screws with a #2 Screw driver to minimize the chance of cracking the frames.

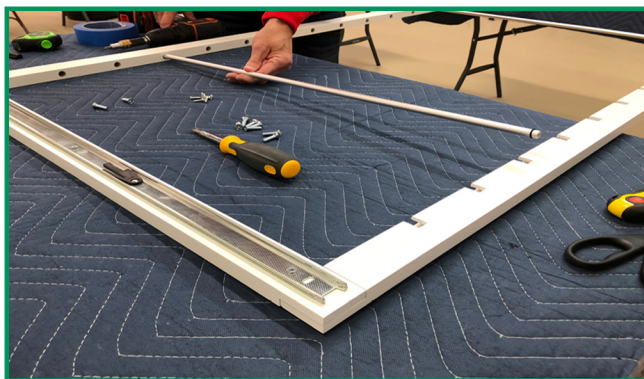

13 - Attach the slider inner member to the top of the frame. Flip the frame over and line up the holes in the slider member with the 3 pilot holes at the top of the frame. Starting with the center hole, screw the 5/8" #6 flat head wood screw in with your drill and #2 Philips bit. Determine which direction the member should face. Be careful not to tighten too hard, so that the screw does not shear off. Finish with your #2 Philips screw driver.

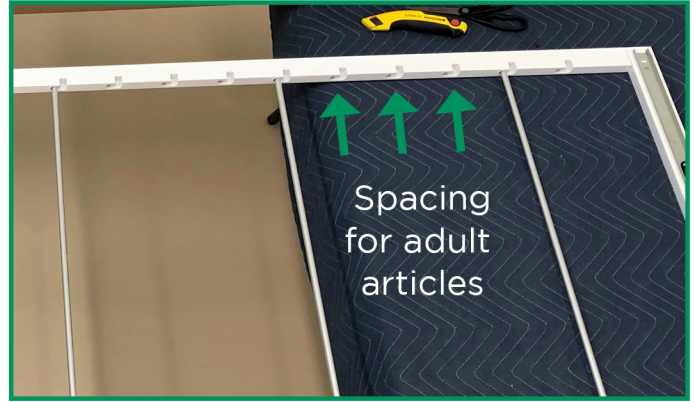
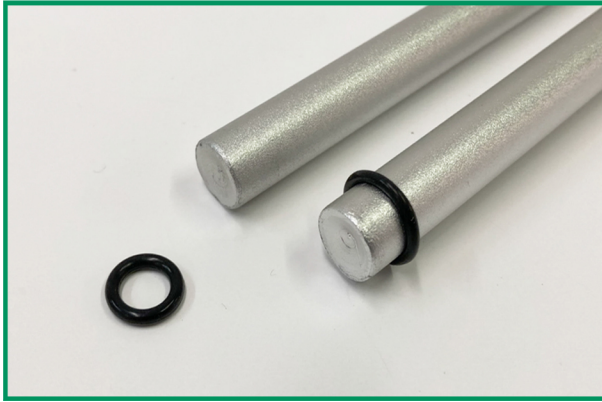

14 - Add a rubber O-ring to one end of each rod by rolling it on 1/4" from the end. Insert the other end of the rod into the hole side and the O-ring side into the slot side of each frame. Normal adult clothes will allow 5 articles per frame with three holes between rods (the 6th spacer rod can be used for smaller articles by moving the rods above and below).



15 - Install the frame onto the slider by holding the frame with one hand in the middle of the top section and the other hand holding the slider vertical with the slider members pushed in and the roller bearing at the receiving end. Repeat until complete.

SCAN CODE WITH PHONE CAMERA BELOW FOR ADDITIONAL HELP

Watch an instructional video on DryAway.net



Tap. Zoom. Rotate with the interactive instructions on the BILT app

